

FEATURES

- 10 A High current switching capacity and high precision
- Wide allowance of operating speed
- Versatile variety of actuators
- UL/C-UL approved

TYPICAL APPLICATION

- General industrial machinery
- Medical equipment
- Measuring instruments
- Transportation equipment
- Home electric appliances

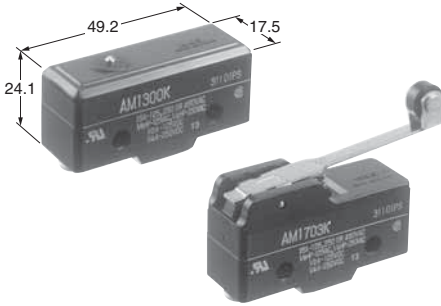

Compliance with RoHS Directive

ORDERING INFORMATION

Ex. AM 1 5 0 1 F

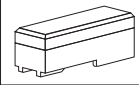
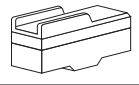
Type of switch	Upper body cover shape & terminal		Basic specifications	Actuators	Contact
NZ basic (AM1) switch	1: Flat, solder terminal 3: Flat, screw terminal 5: Grooved, solder terminal 7: Grooved, screw terminal	Upper body cover shape Flat  Grooved 	0: Standard type 1: Oil tight type 3: Reversed action type 4: One way type	0: Pin plunger 1: Hinge lever (leaf spring) 3: Hinge roller lever (roller, leaf, spring) 4: Hinge short roller lever 5: Overtravel plunger 6: Compact overtravel plunger 7: Panel mount plunger 811: Panel mount roller plunger 812: Panel mount cross roller plunger	F: Cadmium free

Remarks: Not every combination is available. Please refer to the following table, "PRODUCT TYPES".

TERMINAL VARIATION

Standard types, reversed action types and oil tight types are available in two terminal designs, solder and screw terminals, as shown in the above columns:

Differences in dimension between solder and screw terminals are as follows;
mm

Solder terminal

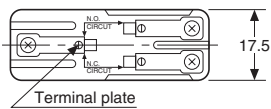
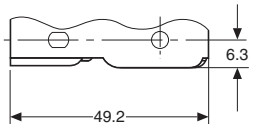

Screw terminal

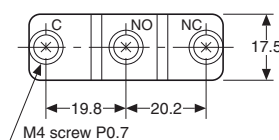
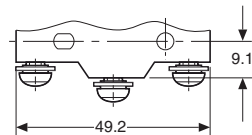

PRODUCT TYPES

1. Standard type

Actuator	Solder terminal	Screw terminal
Pin plunger	AM1100F	AM1300F
Over travel plunger	AM1105F	AM1305F
Compact over travel plunger	AM1106F	AM1306F
Panel mount plunger	AM1107F	AM1307F
Panel mount roller plunger	AM110811F	AM130811F
Panel mount cross roller plunger	AM110812F	AM130812F
Flexible leaf lever	AM1101F	AM1301F
Flexible roller leaf lever	AM1103F	AM1303F
Rigid lever	AM1501F	AM1701F
Rigid short roller lever	AM1504F	AM1704F
Rigid roller lever	AM1503F	AM1703F
One way type•Rigid short roller lever	AM1544F	AM1744F
One way type•Rigid roller lever	AM1543F	AM1743F
Reversed action type•Rigid lever	AM1531F	AM1731F
Reversed action type •Rigid short roller lever	AM1534F	AM1734F
Reversed action type•Rigid roller lever	AM1533F	AM1733F

2. Oil tight types

Actuator	Solder terminal	Screw terminal
Rigid lever	AM1511F	AM1711F
Rigid short roller lever	AM1514F	AM1714F
Rigid roller lever	AM1513F	AM1713F

Remarks: 1. Standard part number indicates UL/C-UL mark.
2. Standard packing for inner carton: 20cps.

SPECIFICATIONS

1. Contact Rating

Type	Voltage	Resistive load ($\cos \phi = 1$)	Inductive load ($\cos \phi = 0.6$ to 0.7)	Motor or lamp load	
				N.C.	N.O.
Standard types One way types Reversed action types	125 V AC	10 A	6 A	3 A	1.5 A
	250 V AC	10 A	6 A	2 A	1 A
	480 V AC	1 A	0.5 A	—	—
	125 V DC	0.5 A	0.05 A	—	—
	250 V DC	0.25 A	0.03 A	—	—
Oil tight types	125 V AC	10 A	6 A	3 A	1.5 A
	250 V AC	10 A	6 A	2 A	1.0 A
	125 V DC	0.5 A	0.05 A	—	—

2. Characteristics

Item		Specifications
Expected life	Mechanical	Pin plunger types (O.T.: specified value)
		Other types (O.T.: specified value)
	Electrical (O.T.: Max.)	
Insulation resistance		Min. 100 M Ω (at 500 V DC)
Dielectric strength	Between open terminals	1,000 Vrms for 1 min.
	Between each terminal and other exposed metal parts	2,000 Vrms for 1 min.
	Between each terminal and ground	2,000 Vrms for 1 min.
Contact resistance (initial) (by voltage drop, 1 A, 6–8 V DC)		Max. 50 m Ω
Vibration resistance (Pin plunger type)		Single amplitude: 0.75 mm, 10 to 55 Hz (contact opening: max. 1 msec.)
Shock resistance	Pin plunger types	Min. 300 m/s ² (contact opening: max. 1 msec.)
	Other types	Min. 50 m/s ² (contact opening: max. 1 msec.)
Allowable operating speed (at no load)		0.1 to 1,000 mm/sec. (at pin plunger position)
Max. operating cycle rate (at no load)		240 cpm
Ambient temperature		–25°C to +80°C (no freezing at low temperature)
Weight		Approx. 20 to 55 g

AM1

OPERATING CHARACTERISTICS

Standard types

Types of actuator	Pin plunger	Overtravel plunger	Compact overtravel plunger	Panel mount plunger
Operating force, max.	3.63 N			
Release force, min.	1.12 N			
Pretravel, max. mm	0.4			
Movement differential, max. mm	0.05			
Overtravel, min. mm	0.13	1.5	1.5	5.6
Operating position, mm	15.9±0.4	28.2±0.5	21.2±0.5	21.8±0.8

Types of actuator	Panel mount roller plunger	Panel mount cross roller plunger	Flexible leaf lever	Flexible roller leaf lever
Operating force, max.	3.63 N		1.47 N	
Release force, min.	1.12 N		0.14 N	
Pretravel, max. mm	0.4		4	
Movement differential, max. mm	0.05		1.3	
Overtravel, min. mm	3.6		1.6	
Operating position, mm	33.3±1.2		17.5±0.8	28.6±0.8

Standard types (cont' d)

Types of actuator	Rigid lever	Rigid short roller lever	Rigid roller lever
Operating force, max.	0.69 N	1.57 N	0.98 N
Release force, min.	0.14 N	0.42 N	0.2 N
Pretravel, max. mm	10	4.5	7.5
Movement differential, max. mm	1.3	0.7	1.3
Overtravel, min. mm	5.6	2.4	3.6
Operating position, mm	19.1±0.7	30.2±0.4	30.2±0.7

One way types

Types of actuator	Rigid short roller lever	Rigid roller lever
Operating force, max.	2.23 N	1.67 N
Release force, min.	0.42 N	0.42 N
Pretravel, max. mm	3.5	4.5
Movement differential, max. mm	0.4	0.5
Overtravel, min. mm	1.5	2.4
Free position, max. mm	31.8	43.3
Operating position, mm	30.2±0.4	41.3±0.4

Reversed action types

Types of actuator	Rigid lever	Rigid short roller lever	Rigid roller lever
Operating force, max.	1.67 N	5.30 N	2.35 N
Release force, min.	0.27 N	1.67 N	0.56 N
Pretravel, max. mm	5.0	2.5	3.6
Movement differential, max. mm	0.9	0.4	0.7
Overtravel, min. mm	5.6	2.0	4.0
Operating position, mm	19.1±0.8	30.2±0.5	30.2±0.8

Oil tight types

Types of actuator	Rigid lever	Rigid short roller lever	Rigid roller lever
Operating force, max.	0.69 N	1.67 N	0.98 N
Release force, min.	0.14 N	0.42 N	0.20 N
Pretravel, max. mm	10	4.5	7.5
Movement differential, max. mm	1.5	0.7	1.3
Overtravel, min. mm	5.6	2.4	3.6
Operating position, mm	19.1±0.7	30.2±0.4	30.2±0.7

DIMENSIONS

The CAD data of the products with a **CAD Data** mark can be downloaded from: <http://panasonic-electric-works.net/ac>

mm General tolerance: ± 0.4

1. Standard types

Pin plunger

CAD Data



AM1100F (Solder terminal)
AM1300F (Screw terminal)

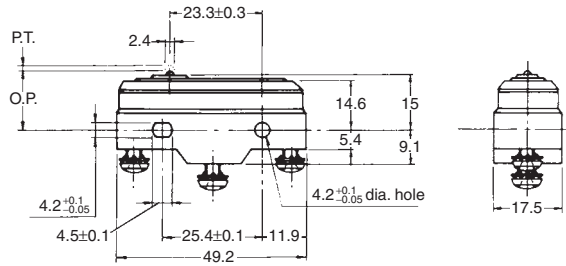

Operating force, max.	3.63 N
Release force, min.	1.12 N
Pretravel, max. mm	0.4
Movement differential, max. mm	0.05
Overtravel, min. mm	0.13
Operating position, mm	15.9±0.4

Overtravel plunger

CAD Data



AM1105F (Solder terminal)
AM1305F (Screw terminal)

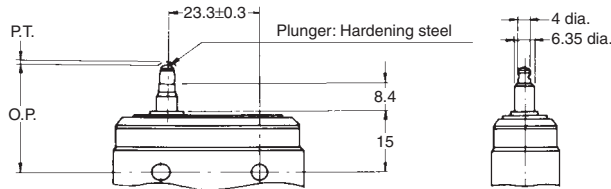

Operating force, max.	3.63 N
Release force, min.	1.12 N
Pretravel, max. mm	0.4
Movement differential, max. mm	0.05
Overtravel, min. mm	1.5
Operating position, mm	28.2±0.5

Compact over plunger

CAD Data



AM1106F (Solder terminal)
AM1306F (Screw terminal)

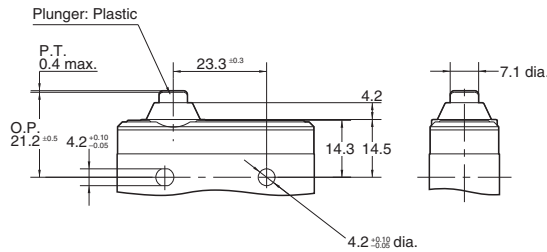

Operating force, max.	3.63 N
Release force, min.	1.12 N
Pretravel, max. mm	0.4
Movement differential, max. mm	0.05
Overtravel, min. mm	1.5
Operating position, mm	21.2±0.5

Panel mount plunger

CAD Data



AM1107F (Solder terminal)
AM1307F (Screw terminal)

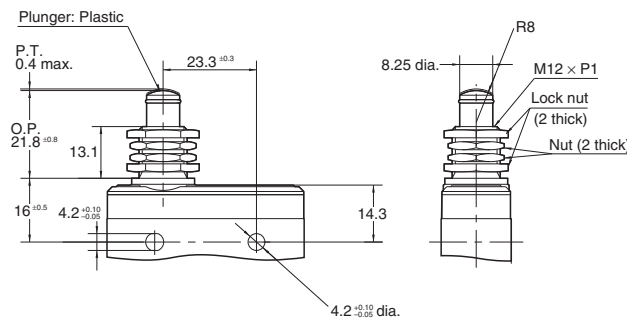

Operating force, max.	3.63 N
Release force, min.	1.12 N
Pretravel, max. mm	0.4
Movement differential, max. mm	0.05
Overtravel, min. mm	5.6
Operating position, mm	21.8±0.8

AM1

Panel mount roller plunger

mm General tolerance: ± 0.4

CAD Data



AM110811F (Solder terminal)
AM130811F (Screw terminal)

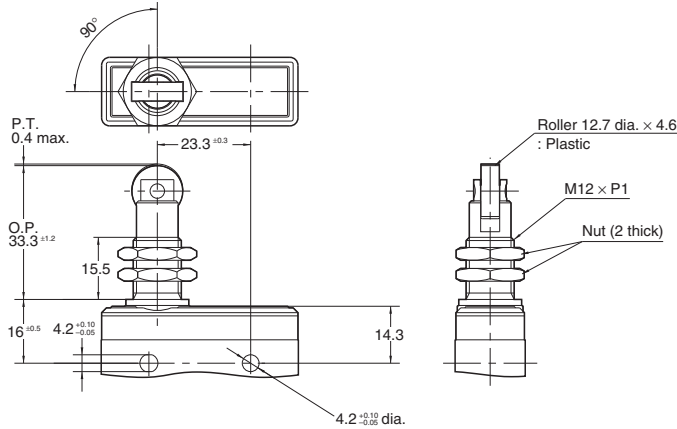

Operating force, max.	3.63 N
Release force, min.	1.12 N
Pretravel, max. mm	0.4
Movement differential, max. mm	0.05
Overtravel, min. mm	3.6
Operating position, mm	33.3±1.2

Panel mount cross roller plunger

CAD Data



AM110812F (Solder terminal)
AM130812F (Screw terminal)

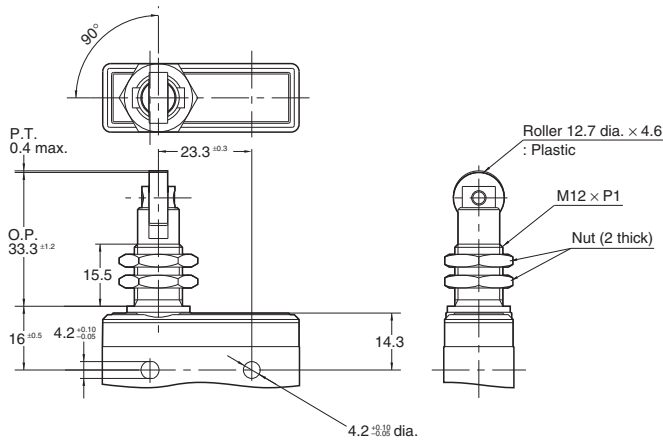

Operating force, max.	3.63 N
Release force, min.	1.12 N
Pretravel, max. mm	0.4
Movement differential, max. mm	0.05
Overtravel, min. mm	3.6
Operating position, mm	33.3±1.2

Dimensions and Operating characteristics are the same as those of Panel mount roller plunger type. However, the roller joins the switch body at an angle of 90°.

Flexible leaf lever

CAD Data



AM1101F (Solder terminal)
AM1301F (Screw terminal)

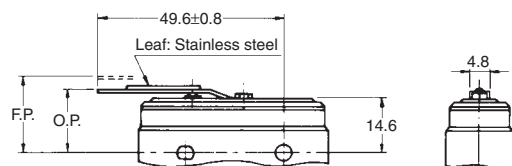

Operating force, max.	1.47 N
Release force, min.	0.14 N
Pretravel, max. mm	4
Movement differential, max. mm	1.3
Overtravel, min. mm	1.6
Operating position, mm	17.5±0.8

Flexible roller leaf lever

CAD Data



AM1103F (Solder terminal)
AM1303F (Screw terminal)

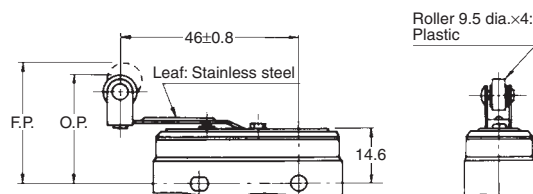

Operating force, max.	1.47 N
Release force, min.	0.14 N
Pretravel, max. mm	4
Movement differential, max. mm	1.3
Overtravel, min. mm	1.6
Operating position, mm	28.6±0.8

Rigid lever

CAD Data

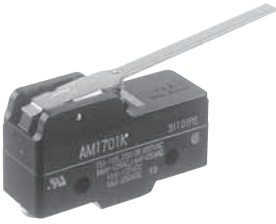

AM1501F (Solder terminal)
AM1701F (Screw terminal)

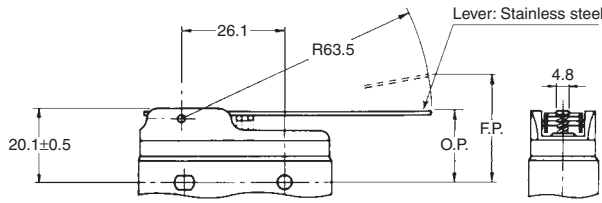

Operating force, max.	0.69 N
Release force, min.	0.14 N
Pretravel, max. mm	10
Movement differential, max. mm	1.3
Overtravel, min. mm	5.6
Operating position, mm	19.1±0.7

Rigid short roller lever

CAD Data



AM1504F (Solder terminal)
AM1704F (Screw terminal)

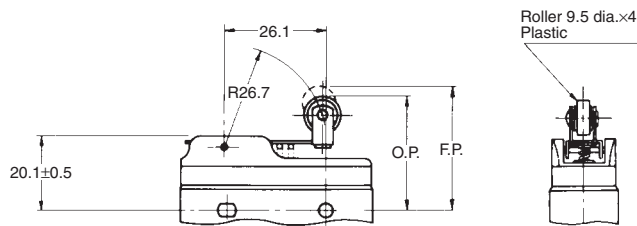

Operating force, max.	1.57 N
Release force, min.	0.42 N
Pretravel, max. mm	4.5
Movement differential, max. mm	0.7
Overtravel, min. mm	2.4
Operating position, mm	30.2±0.4

Rigid roller lever

CAD Data

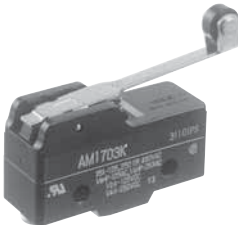

AM1503F (Solder terminal)
AM1703F (Screw terminal)

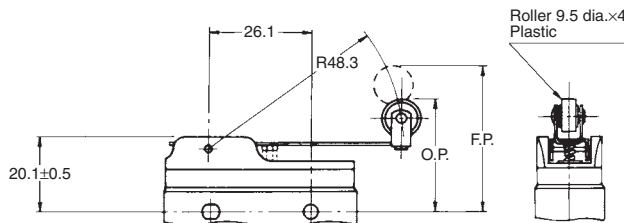

Operating force, max.	0.98 N
Release force, min.	0.2 N
Pretravel, max. mm	7.5
Movement differential, max. mm	1.3
Overtravel, min. mm	3.6
Operating position, mm	30.2±0.7

2. One way types

This type is operated only to one direction, not to the reversed direction by the construction of the roller lever, pivoting away from the cam on the return stroke.

Rigid short roller lever

CAD Data



AM1544F (Solder terminal)
AM1744F (Screw terminal)

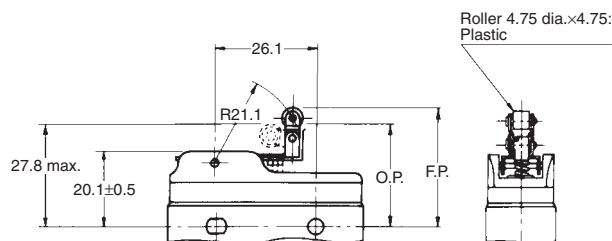

Operating force, max.	2.23 N
Release force, min.	0.42 N
Pretravel, max. mm	3.5
Movement differential, max. mm	0.4
Overtravel, min. mm	1.5
Operating position, mm	30.2±0.4

AM1

Rigid roller lever

mm General tolerance: ± 0.4

CAD Data



AM1543F (Solder terminal)
AM1743F (Screw terminal)

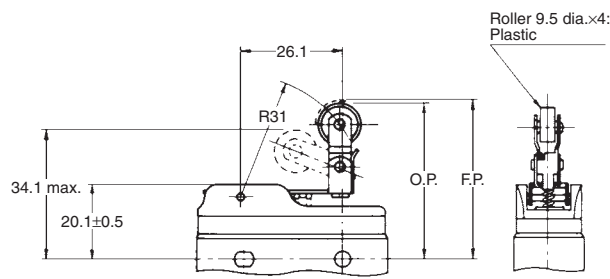

Operating force, max.	1.67 N
Release force, min.	0.42 N
Pretravel, max. mm	4.5
Movement differential, max. mm	0.5
Overtravel, min. mm	2.4
Operating position, mm	41.3 ± 0.4

3. Reversed action types

When the actuator is operated, the switching mechanism returns to the free position. Extraordinary force by pushing the plunger too much is not put on the switching mechanism, which means stability in life.

Rigid lever

CAD Data



AM1531F (Solder terminal)
AM1731F (Screw terminal)

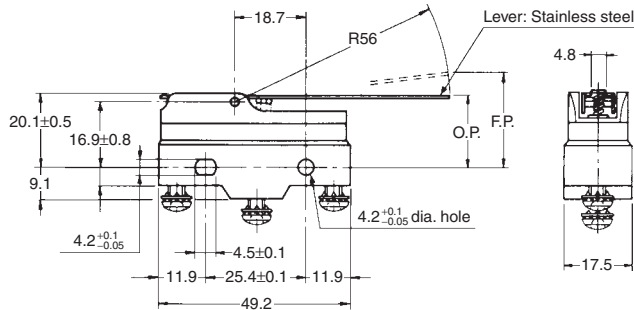

Operating force, max.	1.67 N
Release force, min.	0.27 N
Pretravel, max. mm	5.0
Movement differential, max. mm	0.9
Overtravel, min. mm	5.6
Operating position, mm	19.1 ± 0.8

Rigid short roller lever

CAD Data



AM1534F (Solder terminal)
AM1734F (Screw terminal)

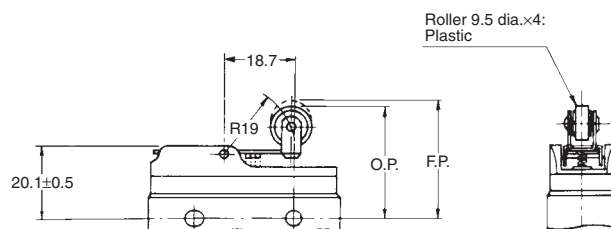

Operating force, max.	5.30 N
Release force, min.	1.67 N
Pretravel, max. mm	2.5
Movement differential, max. mm	0.4
Overtravel, min. mm	2.0
Operating position, mm	30.2 ± 0.5

Rigid roller lever

CAD Data



AM1533F (Solder terminal)
AM1733F (Screw terminal)

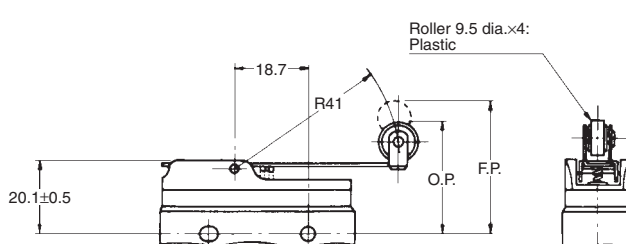

Operating force, max.	2.35 N
Release force, min.	0.56 N
Pretravel, max. mm	3.6
Movement differential, max. mm	0.7
Overtravel, min. mm	4.0
Operating position, mm	30.2 ± 0.8

4. Oil tight types

The pushbutton part is sealed with the rubber cap and the connected part between the cap and body is also coated with resin so that these parts are kept away from foreign matters. This type has resistance to oil.

Rigid lever

CAD Data

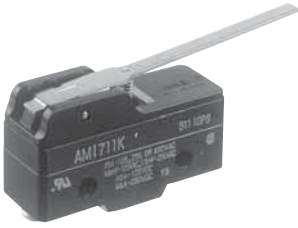

AM1511F (Solder terminal)
AM1711F (Screw terminal)

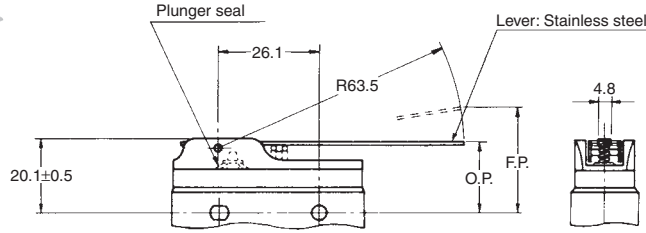

Operating force, max.	0.69 N
Release force, min.	0.14 N
Pretravel, max. mm	10
Movement differential, max. mm	1.5
Overtravel, min. mm	5.6
Operating position, mm	19.1±0.7

Rigid short roller lever

CAD Data



AM1514F (Solder terminal)
AM1714F (Screw terminal)

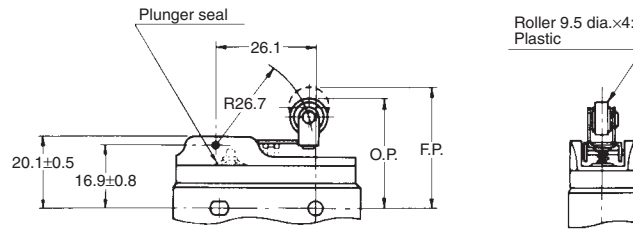

Operating force, max.	1.67 N
Release force, min.	0.42 N
Pretravel, max. mm	4.5
Movement differential, max. mm	0.7
Overtravel, min. mm	2.4
Operating position, mm	30.2±0.4

Rigid roller lever

CAD Data



AM1513F (Solder terminal)
AM1713F (Screw terminal)

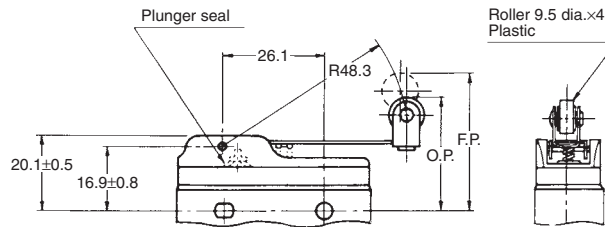

Operating force, max.	0.98 N
Release force, min.	0.20 N
Pretravel, max. mm	7.5
Movement differential, max. mm	1.3
Overtravel, min. mm	3.6
Operating position, mm	30.2±0.7

NOTES

1. Regarding fastening of switch body

- 1) In fastening the switch body, use M4 mounting screws to attach switches with the torque 1.5 N·m or less.
- 2) After mounting and wiring, the insulation distance between ground and each terminal should be confirmed as sufficient.

2. Adjustment of the operating device

The operating device should be positioned so that it applies no stress to the pushbutton or actuator when the switch is in the open position. If this condition is exceeded, the mechanical and electrical performance will be

impaired. In addition, the force applied by the operating device should be in a perpendicular direction. Even if the pushbutton is used in the full total travel position, there will be no influence on the life of the switch.

3. Soldering operations

Soldering should be done in less than 5 seconds, with a 60 watt iron (tip temperature = 350°C max.). Care should be taken not to apply force to the terminal during soldering.

4. Avoid using switches in the following conditions:

- In corrosive gases such as hydrogen sulfide.
- In flammable or explosive gases such as gasoline or thinner etc.
- In a dusty environment.
- In an ambient humidity over 85%.
- In conditions where the perpendicular operating speed is less than 0.1 mm/sec. or more than 1,000 mm/sec.
- In a silicon atmosphere.

5. Others

Caution should be taken not to drop switches.

North America

Europe

Asia Pacific

China

Japan

Panasonic Electric Works

Please contact our Global Sales Companies in:

Europe

▶ Headquarters	Panasonic Electric Works Europe AG	Rudolf-Diesel-Ring 2, 83607 Holzkirchen, Tel. +49 (0) 8024 648-0, Fax +49 (0) 8024 648-111, www.panasonic-electric-works.com
▶ Austria	Panasonic Electric Works Austria GmbH	Rep. of PEWDE, Josef Madersperger Str. 2, 2362 Biedermansdorf, Tel. +43 (0) 2236-26846, Fax +43 (0) 2236-46133 www.panasonic-electric-works.at
	PEW Electronic Materials Europe GmbH	Ennshafenstraße 30, 4470 Enns, Tel. +43 (0) 7223 883, Fax +43 (0) 7223 88333, www.panasonic-electronic-materials.com
▶ Benelux	Panasonic Electric Works Sales Western Europe B.V.	De Rijn 4, (Postbus 211), 5684 PJ Best, (5680 AE Best), Netherlands, Tel. +31 (0) 499 372727, Fax +31 (0) 499 372185, www.panasonic-electric-works.nl
▶ Czech Republic	Panasonic Electric Works Czech s.r.o.	Průmyslová 1, 34815 Planá, Tel. (+420)-374 799 990, Fax (+420)-374 799 999, www.panasonic-electric-works.cz
▶ France	Panasonic Electric Works Sales Western Europe B.V.	Succursale française, 10, rue des petits ruisseaux, 91370 Verrières Le Buisson, Tél. +33 (0) 1 6013 5757, Fax +33 (0) 1 6013 5758, www.panasonic-electric-works.fr
▶ Germany	Panasonic Electric Works Deutschland GmbH	Rudolf-Diesel-Ring 2, 83607 Holzkirchen, Tel. +49 (0) 8024 648-0, Fax +49 (0) 8024 648-555, www.panasonic-electric-works.de
▶ Hungary	Panasonic Electric Works Europe AG	Erdőalja út 91/a, 1037 Budapest, Tel. +36 (0) 20 9715688, www.panasonic-electric-works.hu
▶ Ireland	Panasonic Electric Works UK Ltd.	Dublin, Tel. +353 (0) 14600969, Fax +353 (0) 14601131, www.panasonic-electric-works.co.uk
▶ Italy	Panasonic Electric Works Italia srl	Via del Commercio 3-5 (Z.I. Ferlina), 37012 Bussolengo (VR), Tel. +39 (0) 456752711, Fax +39 (0) 456700444, www.panasonic-electric-works.it
▶ Nordic Countries	Panasonic Electric Works Nordic AB	Sjöängsvägen 10, 19272 Sollentuna, Sweden, Tel. +46 859476680, Fax +46 859476690, www.panasonic-electric-works.se
▶ Poland	Panasonic Electric Works Polska sp. z o.o	Jungmansgatan 12, 21119 Malmö, Tel. +46 40 697 7000, Fax +46 40 697 7099, www.panasonic-fire-security.com
▶ Portugal	Panasonic Electric Works España S.A.	Al. Krakowska 4/6, 02-284 Warszawa, Tel. +48 (0) 22 338-11-33, Fax +48 (0) 22 338-12-00, www.panasonic-electric-works.pl
▶ Spain	Panasonic Electric Works España S.A.	Portuguese Branch Office, Avda Adelino Amaro da Costa 728 R/C J, 2750-277 Cascais, Tel. +351 214812520, Fax +351 214812529
▶ Switzerland	Panasonic Electric Works Schweiz AG	Barajas Park, San Severo 20, 28042 Madrid, Tel. +34 913293875, Fax +34 913292976, www.panasonic-electric-works.es
▶ United Kingdom	Panasonic Electric Works UK Ltd.	Grundstrasse 8, 6343 Rotkreuz, Tel. +41 (0) 41 7997050, Fax +41 (0) 41 7997055, www.panasonic-electric-works.ch
		Sunrise Parkway, Linford Wood, Milton Keynes, MK14 6 LF, Tel. +44 (0) 1908 231555, Fax +44 (0) 1908 231599, www.panasonic-electric-works.co.uk

North & South America

▶ USA	PEW Corporation of America	629 Central Avenue, New Providence, N.J. 07974, Tel. 1-908-464-3550, Fax 1-908-464-8513, www.pewa.panasonic.com
--------------	-----------------------------------	---

Asia Pacific/China/Japan

▶ China	Panasonic Electric Works (China) Co., Ltd.	Level 2, Tower W3, The Towers Oriental Plaza, No. 2, East Chang An Ave., Dong Cheng District, Beijing 100738, Tel. (010) 5925-5988, Fax (010) 5925-5973
▶ Hong Kong	Panasonic Electric Works (Hong Kong) Co., Ltd.	RM1205-9, 12/F, Tower 2, The Gateway, 25 Canton Road, Tsimshatsui, Kowloon, Hong Kong, Tel. (0852) 2956-3118, Fax (0852) 2956-0398
▶ Japan	Panasonic Electric Works Co., Ltd.	1048 Kadoma, Kadoma-shi, Osaka 571-8686, Japan, Tel. (06) 6908-1050, Fax (06) 6908-5781, http://panasonic-electric-works.net
▶ Singapore	Panasonic Electric Works Asia Pacific Pte. Ltd.	101 Thomson Road, #25-03/05, United Square, Singapore 307591, Tel. (06255) 5473, Fax (06253) 5689